

# Pressure control valves type AGIR, AGIS, AGIU

two stage, subplate mounting, ISO 5781 sizes 10, 20 and 32

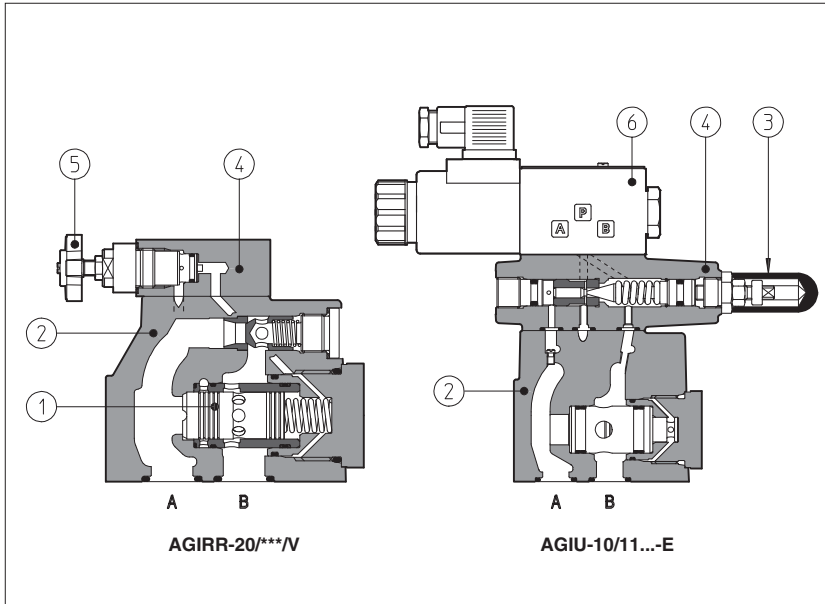

Two stage pressure control valves with balanced poppet designed to operate in oil hydraulic systems.

**AGIR:** pressure reducing;

**AGIS:** sequence;

**AGIU:** unloading.

In standard versions the piloting pressure of the poppet (1) of the main stage (2) is regulated by means of a grub screw protected by cap (3) in the cover (4).

Optional versions with setting adjustment by handwheel (5) instead of the grub screw are available on request.

Clockwise rotation increases pressure.

Unloading valves AGIU can be equipped with a venting solenoid valve (6) type:

- DHI for AC and DC supply, with **cURus** certified solenoids

- DHE for AC and DC supply, high performances with **cURus** certified solenoids

Mounting surface: **ISO 5781 size 10, 20 and 32**

Max flow:

**AGIR = 160, 300, 400 l/min**

**AGIS = 200, 400, 600 l/min**

**AGIU = 100, 200, 300 l/min**

Pressure up to **350 bar**

## 1 MODEL CODE

<b>AGIU</b>	*	-	20	/	10	/	210	/	V	-	I	X	24DC	**	/	*	
Pressure control valves subplate mounting <b>AGIR</b> = pressure reducing <b>AGIS</b> = sequence <b>AGIU</b> = unloading																	Seals material, see section 3: - = NBR PE = FKM BT = HNBR
Only for AGIR and AGIS: <b>R</b> = with check valve - = without check valve																	Series number
Size: <b>10 20 32</b>																	Voltage code, see section 7 (1)
Optional solenoid valve for venting (1) <b>10</b> = venting with de-energized solenoid <b>11</b> = venting with energized solenoid																	<b>X</b> = without connector (1): See section 7 for available connectors, to be ordered separately <b>-00</b> = solenoid valve without coils (for -I) <b>-00-AC</b> = AC solenoid valve without coils (for -E) <b>-00-DC</b> = DC solenoid valve without coils (for -E)
Pressure range: <b>50</b> = 4÷50 bar (AGIR*); <b>100</b> = 6÷100 bar; <b>210</b> = 7÷210 bar; <b>350</b> = 8÷350 bar																	
Options (2): <b>V</b> = regulating handwheel instead of a grub screw protected by cap <b>VF</b> = regulating knob instead of a grub screw protected by cap (only for AGIS, AGIU) <b>VS</b> = manual override with safety locking instead of a grub screw protected by cap (only for AGIS, AGIU)																	
Only for AGIU: <b>D</b> = internal drain <b>WP</b> = prolonged manual override protected by rubber cap (1) - = standard unloading characteristics <b>5, 6, 7</b> = other unloading characteristics, see section 5																	
																	Pilot valve (1): <b>I</b> = DHI for AC and DC supply, with <b>cURus</b> certified solenoids <b>E</b> = DHE for AC and DC supply, high performances with <b>cURus</b> certified solenoids

(1) Only for AGIU with solenoid valve for venting

(2) For handwheel features, see technical table K150

## 2 HYDRAULIC CHARACTERISTICS

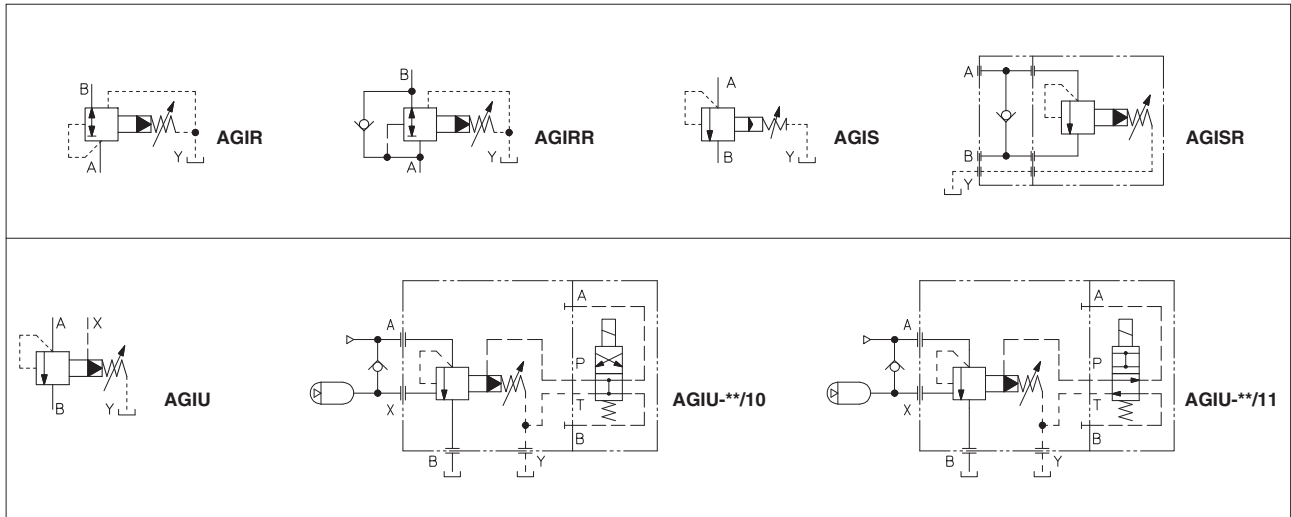

Valve model	AGIR-10	AGIR-20	AGIR-32	AGIS-10	AGIS-20	AGIS-32	AGIU-10	AGIU-20	AGIU-32
Max flow [l/min]	160	300	400	200	400	600	100	200	300
Pressure range [bar]	4÷50 (AGIR*);			6÷100;		7÷210;	8÷350		
Max pressure [bar]	Ports A, B, X = 350 bar					Port Y = 0			

## 3 MAIN CHARACTERISTICS, SEALS AND FLUIDS - for other fluids not included in below table, consult our technical office

Assembly position	Any position		
Subplate surface finishing	Roughness index Ra 0,4 - flatness ratio 0,01/100 (ISO 1101)		
Ambient temperature	Standard execution = -30°C ÷ +70°C /PE option = -20°C ÷ +70°C /BT option = -40°C ÷ +70°C		
Seals, recommended fluid temperature	NBR seals (standard) = -20°C ÷ +60°C, with HFC hydraulic fluids = -20°C ÷ +50°C FKM seals (/PE option) = -20°C ÷ +80°C HNBR seals (/BT option) = -40°C ÷ +60°C, with HFC hydraulic fluids = -40°C ÷ +50°C		
Recommended viscosity	15÷100 mm <sup>2</sup> /s - max allowed range 2,8 ÷ 500 mm <sup>2</sup> /s		
Fluid contamination class	ISO 4406 class 21/19/16 NAS 1638 class 10, in line filters of 25 µm (β10 ≥75 recommended)		
<b>Hydraulic fluid</b>	<b>Suitable seals type</b>	<b>Classification</b>	<b>Ref. Standard</b>
Mineral oils	NBR, FKM, HNBR	HL, HLP, HLPD, HVLP, HVLPD	DIN 51524
Flame resistant without water	FKM	HF DU, HF DR	ISO 12922
Flame resistant with water	NBR, HNBR	HFC	

### 3.1 Coils characteristics

Insulation class	DHI pilot DHE pilot	<b>H</b> (180°C) <b>H</b> (180°C) for DC coils <b>F</b> (155°C) for AC coils	Due to the occurring surface temperatures of the solenoid coils, the European standards EN ISO 13732-1 and EN ISO 4413 must be taken into account
Protection degree to DIN EN 60529		<b>IP 65</b> (with connectors 666, 667, 669 or E-SD correctly assembled)	
Relative duty factor		100%	
Supply voltage and frequency		See electric feature	
Supply voltage tolerance		± 10%	
Certification		<b>cURus</b> North American standard	

**4 REGULATED PRESSURE VERSUS FLOW DIAGRAMS** based on mineral oil ISO VG 46 at 50°C

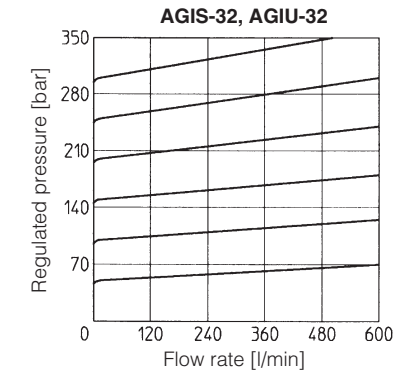
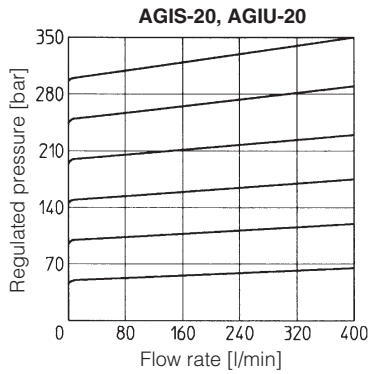
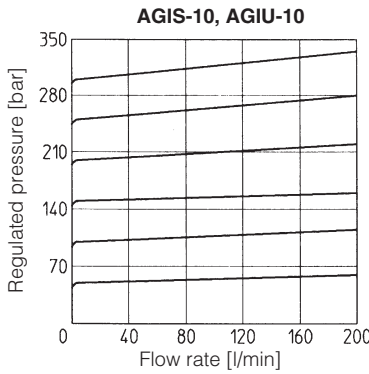
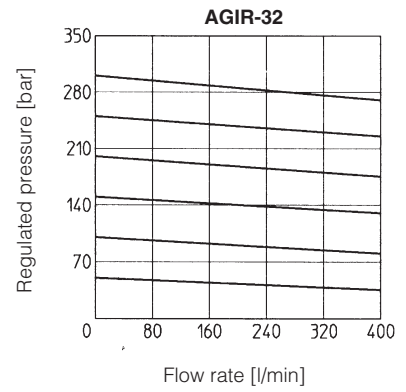
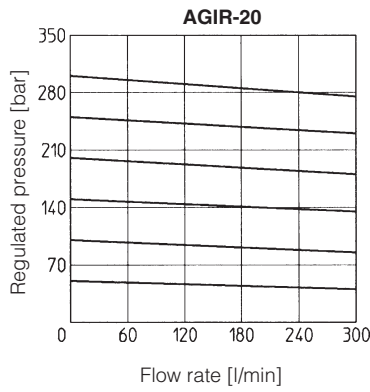
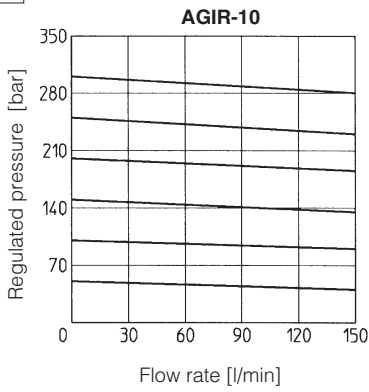

**Note:** for AGIU-10, the max flow rate is 100 l/min

**Note:** for AGIU-20, the max flow rate is 200 l/min

**Note:** for AGIU-32, the max flow rate is 300 l/min

**5 OPERATING DIAGRAM**

based on mineral oil ISO VG 46 at 50°C

- 1 = AGIR-10 A → B
- 2 = AGIR-20 A → B
- 3 = AGIR-32 A → B
- 4 = AGIR-10 B → A
- 5 = AGIR-20 B → A
- 6 = AGIR-32 B → A

- 7 = AGIS-10
- 8 = AGIS-20
- 9 = AGIS-32

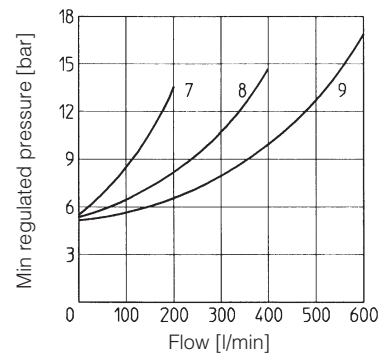
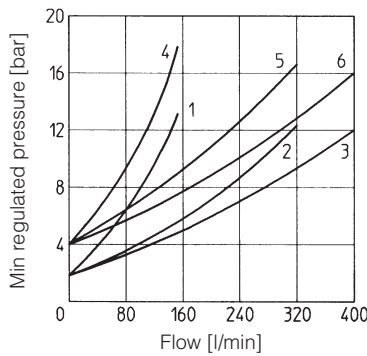

**Opening/closing diagram for AGIU**

- 1 = AGIU-\*/.../standard    3 = AGIU-\*/.../6
- 2 = AGIU-\*/.../5        4 = AGIU-\*/.../7

**NOTES**

- 1) Short pipes with low resistance must be used between the unloading valve and the accumulator;
- 2) When the resistance is high, the hydraulic pilot signal must be taken as closed as possible to the accumulator;
- 3) With high pump flow and small valve differential pressure of intervention it is unadvisable to use the version with external drain;
- 4) When to use the BA-\*25 subplates:
  - a) in applications with working frequencies >10 Hz use subplates type BA-\*25/4 (spring with 4 bar of cracking pressure);
  - b) in applications with working frequencies <10 Hz use subplates type BA-\*25/2 (spring with 2 bar of cracking pressure);

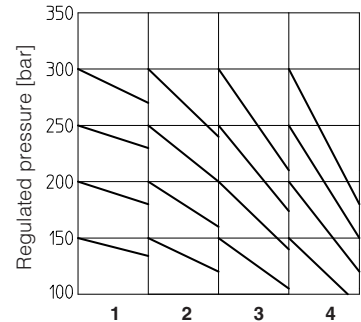
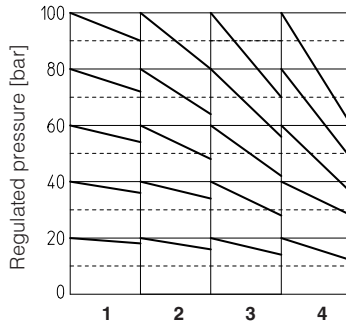

**6 ELECTRIC CONNECTORS ACCORDING TO DIN 43650 FOR AGIU WITH SOLENOID VALVE**

The connectors must be ordered separately

Code of connector	Function
<b>666</b>	Connector IP-65, suitable for direct connection to electric supply source
<b>667</b>	As 666 connector IP-65 but with built-in signal led, suitable for direct connection to electric supply source

For other available connectors, see tab. E010 and K500

**7 ELECTRIC FEATURES FOR AGAM WITH SOLENOID VALVE**

Solenoid valve type	External supply nominal voltage ± 10% (1)		Voltage code	Type of connector	Power consumption (3)		Code of spare coil DHI	Colour of coil label DHI	Code of spare coil DHE
					DHI	DHE			
DHI DHE	DC	12 DC 24 DC 110 DC 220 DC	<b>12 DC</b> <b>24 DC</b> <b>110 DC</b> <b>220 DC</b>	666 or 667	33 W	30 W	COU-12DC COU-24DC COU-110DC COU-220DC	green red black black	COE-12DC COE-24DC COE-110DC COE-220DC
		AC	110/50 AC (2) 115/60 AC 120/60 AC 230/50 AC (2) 230/60 AC	<b>110/50/60 AC</b> <b>115/60 AC (5)</b> <b>120/60 AC (6)</b> <b>230/50/60 AC</b> <b>230/60 AC</b>	666 or 667	60 VA - 60 VA 60 VA 60 VA	58 VA 80 VA - 58 VA 80 VA	COI-110/50/60AC - COI-120/60AC COI-230/50/60AC COI-230/60AC	yellow - white light blue silver

(1) For other supply voltages available on request see technical tables E010, E015.

(2) Coil can be supplied also with 60 Hz of voltage frequency: in this case the performances are reduced by 10 ÷ 15% and the power consumption is 55 VA (DHI) and 58 VA

(3) Average values based on tests performed at nominal hydraulic condition and ambient/coil temperature of 20°C.

(4) When solenoid is energized, the inrush current is approx 3 times the holding current.

(5) Only for DHE

(6) Only for DHI

**8 DIMENSIONS [mm]**

**AGIR, AGIS, AGIU size 10**

**ISO 5781: 2000**

**Mounting surface: 5781-06-07-0-00**

Fastening bolts:

4 socket head screws M10x45 class 12.9

Tightening torque = 70 Nm

Seals: 2 OR 109/70, 2 OR 3068

Ports A, B: Ø = 14 mm

Ports X, Y: Ø = 5 mm

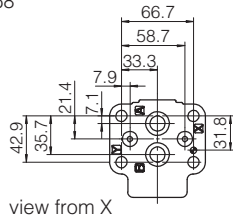

view from X

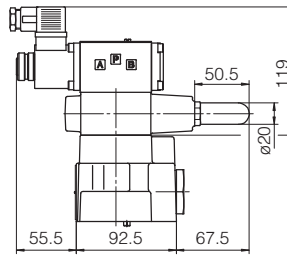

**AGIU-10/10/\*\*-IX**  
Mass = 5,3 Kg

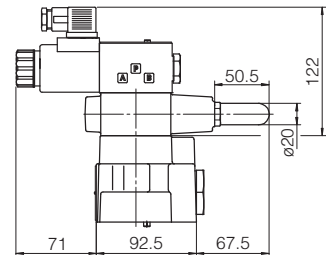

**AGIU-10/10/\*\*-EX**  
Mass = 5,6 Kg

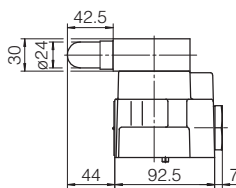

**AGIR-10;** Mass= 3,3 Kg  
**AGIRR-10;** Mass= 3,5 Kg

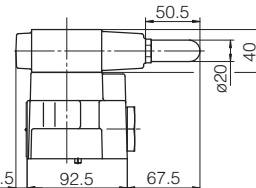
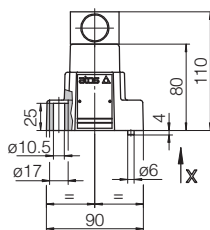

**AGIS-10;** Mass= 3,8 Kg  
**AGIU-10;** Mass= 3,8 Kg

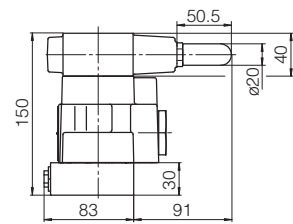

**AGISR-10;** Mass= 5,3 Kg

**AGIR, AGIS, AGIU size 20**

**ISO 5781: 2000**

**Mounting surface: 5781-08-10-0-00**

Fastening bolts:

4 socket head screws M10x45 class 12.9

Tightening torque = 70 Nm

Seals: 2 OR 109/70, 2 OR 4100

Ports A, B: Ø = 22 mm

Ports X, Y: Ø = 5 mm

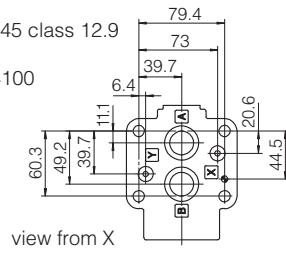

view from X

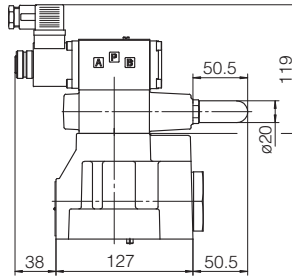

**AGIU-20/10/\*\*-IX**  
Mass = 7,5 Kg

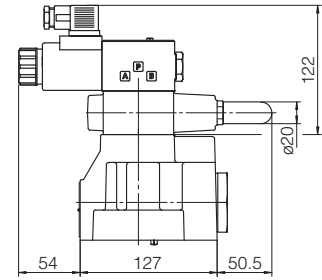

**AGIU-20/10/\*\*-EX**  
Mass = 7,8 Kg

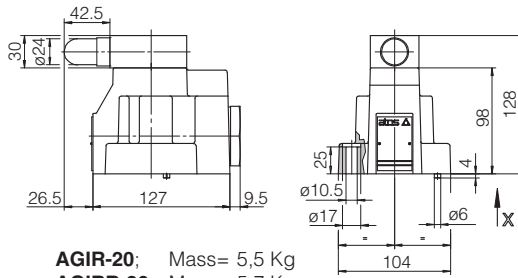

**AGIR-20;** Mass= 5,5 Kg  
**AGIRR-20;** Mass= 5,7 Kg

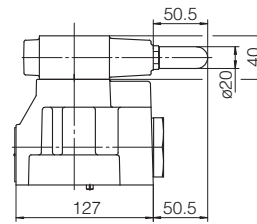

**AGIS-20;** Mass= 6 Kg  
**AGIU-20;** Mass= 6 Kg

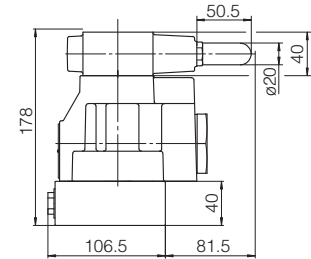

**AGISR-20;** Mass= 9 Kg

**AGIR, AGIS, AGIU size 32**

**ISO 5781: 2000**

**Mounting surface: 5781-08-13-0-00**

Fastening bolts:

6 socket head screws M10x45 class 12.9

Tightening torque = 70 Nm

Seals: 2 OR 109/70, 2 OR 4131

Ports A, B: Ø = 28 mm

Ports X, Y: Ø = 5 mm

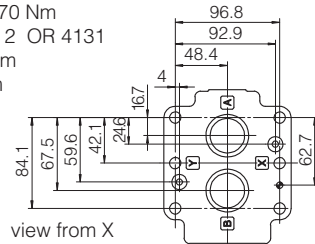

view from X

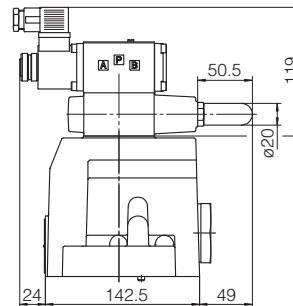

**AGIU-32/10/\*\*-IX**  
Mass = 11,4 Kg

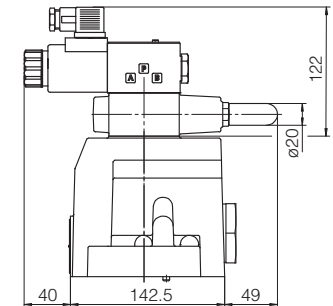

**AGIU-32/10/\*\*-EX**  
Mass = 11,7 Kg

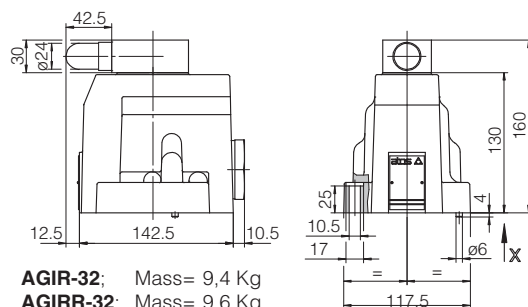

**AGIR-32;** Mass= 9,4 Kg  
**AGIRR-32;** Mass= 9,6 Kg

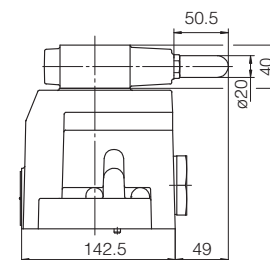

**AGIS-32;** Mass= 9,9 Kg  
**AGIU-32;** Mass= 9,9 Kg

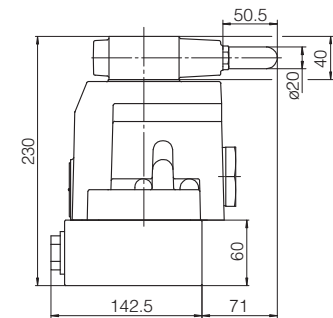

**AGISR-32;** Mass= 15.5 Kg

Overall dimensions refer to valves with connectors type 666

**9 MOUNTING SUBPLATES**

Valves	Subplate model	Port location	Ports				Ø Counterbore [mm]				Mass [Kg]
			A	B	X-Y	OUT	A	B	X-Y	OUT	
<b>AGI*-10</b>	BA-305	Ports A, B, Y underneath;	G 1/2"	G 1/2"	G 1/4"	-	30	30	21,5	-	1
<b>AGI*-20</b>	BA-505		G 1"	G 1"	G 1/4"	-	46	46	21,5	-	2
<b>AGI*-32</b>	BA-705		G 1 1/2"	G 1 1/2"	G 1/4"	-	63,5	63,5	21,5	-	7,5
<b>AGIU-10</b>	BA-325 (with incorporated check valve)	G 1/2"	G 3/4"	G 1/4"	G 1/2"	30	36,5	21,5	30	5	
<b>AGIU-20</b>	BA-425 (with incorporated check valve)	Ports A, B, Y underneath;	G 1"	G 1"	G 1/4"	G 1"	46	46	21,5	46	6,5
<b>AGIU-32</b>	BA-625 (with incorporated check valve)		G 1 1/2"	G 1 1/2"	G 1/4"	G 1 1/2"	63,5	63,5	21,5	63,5	13

The subplates are supplied with fastening bolts. For further details see table K280

