

Proportional relief valves with integral pressure transducer

digital, direct operated, closed loop high performances, rugged design

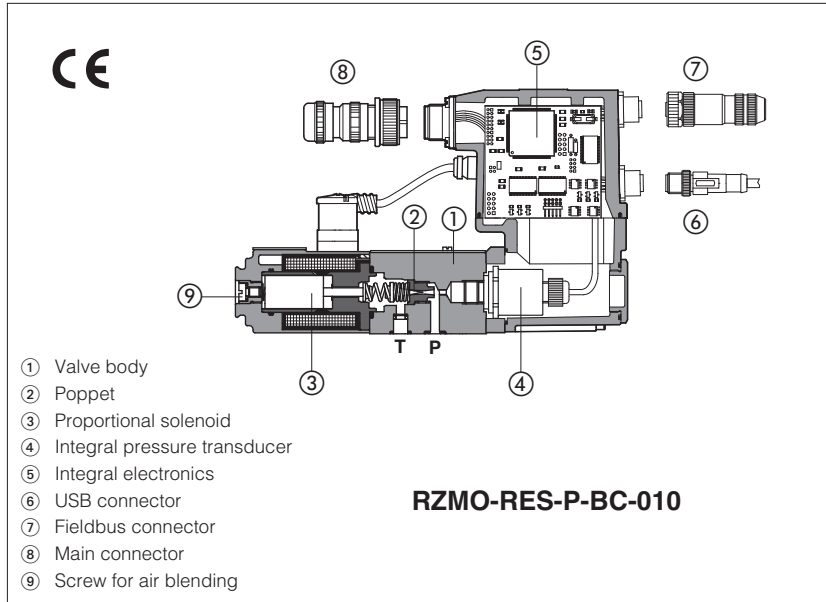

RZMO-R, RZMO-REB, RZMO-RES

Poppet type direct operated digital proportional relief valves with integral pressure transducer for pressure closed loop controls.

Executions:

- **R** without integral driver, to be coupled with separated driver type E-BM-RES, see table GS203
- **REB** with basic integral digital electronic driver, analog reference signals and USB port for software functional parameters setting
- **RES** with full integral digital electronic driver and fieldbus interface for functional parameters setting, reference signals and real-time diagnostics

The integral digital electronic driver performs the valve's hydraulic regulation according to the reference signal and assures valve-to-valve interchangeability thanks to the factory presetting

Size: **06**
 Max flow: **4 l/min**
 Max pressure: **350 bar**

1 MODEL CODE

RZMO	-	R	EB	-	P	-	NP	-	010	/	315	/	*	/	**	/	*
-------------	---	----------	-----------	---	----------	---	-----------	---	------------	---	------------	---	----------	---	-----------	---	----------

Proportional pressure relief valve size 06

R = closed loop pressure control

- = omit for execution with separated driver see section 2

EB = basic integral driver
ES = full integral driver

P = with integral pressure transducer

Fieldbus interfaces - USB port always present (1):
NP = Not present **BP** = PROFIBUS DP
BC = CANopen **EH** = EtherCAT

Seals material, see sect. 5, 6:
 - = NBR
PE = FKM
BT = HNBR

Series number

Electronics options
 only for **REB** and **RES** - see section 10:
I = current reference input and monitor 4÷20 mA (omit for standard voltage reference input 0÷10 V)
Q = enable signal
Z = double power supply, enable, fault and monitor signals - 12 pin connector

Configuration:
010 = regulation on port P, discharge in T (direct operated version)

Max regulated pressure:
100 = 100 bar **315** = 315 bar
210 = 210 bar **350** = 350 bar

(1) Omit for **R** execution; **REB** available only in version **NP**; **RES** available only in version **BC, BP, EH**

2 ELECTRONIC DRIVERS

Valve model	R	REB	RES
Drivers model	E-BM-RES	E-RI-REB	E-RI-RES
Type	Digital		
Format	DIN rail panel format	Integral to valve	
Data sheet	GS203	GS205	

Note: for main and communication connectors see sections 12, 13

Hydraulic symbol

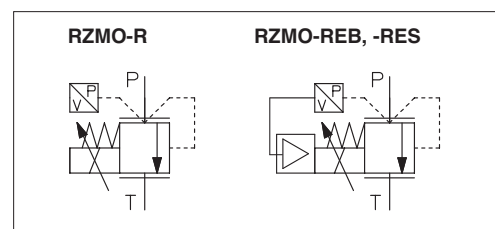

3 GENERAL NOTES

RZMO-R* proportional valves are CE marked according to the applicable Directives (e.g. Immunity/Emission EMC Directive and Low Voltage Directive). Installation, wirings and start-up procedures must be performed according to the general prescriptions shown in table F003 and in the installation notes supplied with relevant components.

The electrical signals of the valve (e.g. monitor signals) must not be directly used to activate safety functions or components, as prescribed by the European standards (Safety requirements of fluid technology systems and components-hydraulics, EN-982).

4 FIELDBUS - only for RES

Fieldbus allows the direct communication of the proportional valve with machine control unit for digital reference signal, diagnostics and settings of functional parameters. Analog reference signal remain available on the main connector for quick commissioning and maintenance. For detailed information about fieldbus features and specification see tech table **GS510**.

5 MAIN CHARACTERISTICS - based on mineral oil ISO VG 46 at 50 °C

Assembly position	Any position			
Subplate surface finishing	Roughness index, Ra 0,4 flatness ratio 0,01/100 (ISO 1101)			
MTTFd valves according to EN ISO 13849	150 years, see technical table P007			
Ambient temperature range	R: standard = -20°C ÷ +70°C,		/BT option = -40°C ÷ +60°C	
	REB, RES: standard = -20°C ÷ +60°C,		/BT option = -40°C ÷ +60°C	
Storage temperature range	R: standard = -20°C ÷ +80°C,		/BT option = -40°C ÷ +70°C	
	REB, RES: standard = -20°C ÷ +70°C,		/BT option = -40°C ÷ +70°C	
Coil resistance R at 20°C	3 ÷ 3,3 Ω			
Max. solenoid current	2,6 A			
Max. power	R = 30 Watt REB, RES = 50 Watt			
Pressure transducer	E-ATR-8/*/I output signal = 4 ÷ 20 mA - see tech. table GS465			
Insulation class	H (180°) Due to the occurring surface temperatures of the solenoid coils, the European standards ISO 13732-1 and EN982 must be taken into account			
Protection degree to DIN EN60529	IP66/67 with mating connectors			
Tropicalization (only REB, RES)	Tropical coating on electronics PCB			
Duty factor	Continuous rating (ED=100%)			
EMC, climate and mechanical load	See technical table G004			
Communication interface (only REB, RES)	USB Atos ASCII coding	CANopen EN50325-4 + DS408	PROFIBUS DP EN50170-2/IEC61158	EtherCAT IEC 61158
Communication physical layer (only REB, RES)	not insulated USB 2.0 + USB OTG	optical insulated CAN ISO11898	optical insulated RS485	Fast Ethernet, insulated 100 Base TX

	[bar]	100	210	315	350
Max regulated pressure	[bar]	100	210	315	350
Min. regulated pressure	[bar]	see min. pressure/flow diagrams at section 7			
Max. pressure at port P	[bar]	350			
Max. pressure at port T	[bar]	210			
Max. flow	[l/min]	4			
Response time 0-100% step signal (1) (depending on installation)	[ms]	≤ 55			
Hysteresis	[% of the max pressure]	≤ 0,3			
Linearity	[% of the max pressure]	≤ 1,0			
Repeatability	[% of the max pressure]	≤ 0,2			
Thermal drift		zero point displacement < 1% at ΔT = 40°C			

Notes: above performance data refer to valves coupled with Atos electronic drivers, see section 2

(1) Average response time value; the pressure variation in consequence of a modification of the reference input signal to the valve is affected by the stiffness of the hydraulic circuit: greater is the stiffness of the circuit, faster is the dynamic response, see section 8.

6 SEALS AND HYDRAULIC FLUID - for other fluids not included in below table, consult our technical office

Seals, recommended fluid temperature	NBR seals (standard) = -20°C ÷ +60°C, with HFC hydraulic fluids = -20°C ÷ +50°C FKM seals (/PE option) = -20°C ÷ +80°C HNBR seals (/BT option) = -40°C ÷ +60°C, with HFC hydraulic fluids = -40°C ÷ +50°C		
Recommended viscosity	20 ÷ 100 mm ² /s - max allowed range 15 ÷ 380 mm ² /s		
Fluid contamination class	ISO 4406 class 20/18/15 NAS 1638 class 9, achievable with in line filter - 10 μm (β10 ≥75 recommended)		
	Hydraulic fluid	Suitable seals type	Classification
Mineral oils	NBR, FKM, HNBR	HL, HLP, HLPD, HVLP, HVLPD	DIN 51524
Flame resistant without water	FKM	HFDU, HFDR	ISO 12922
Flame resistant with water	NBR, HNBR	HFC	

7 DIAGRAMS (based on mineral oil ISO VG 46 at 50 °C)

1 Regulation diagrams
with flow rate Q = 1 l/min

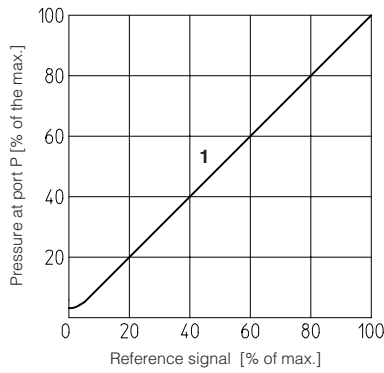

2 Pressure/flow diagrams
with reference signal set at Q = 1 l/min

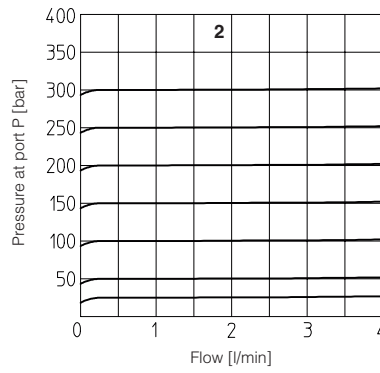

3-6 Min. pressure/flow diagrams
with zero reference signal

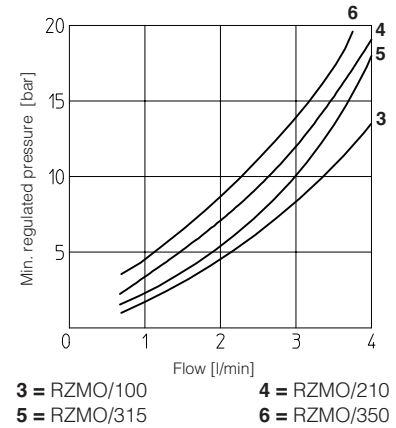

8 DYNAMIC RESPONSE - 4 pressure PIDs

The valve is provided with 4 PIDs configurations to match different hydraulic conditions. The required PID configuration can be selected before the valve commissioning, through Atos E-SW software via USB port. Only for **RES** the PID can be also selected in real time, through PLC via fieldbus.

PID	Dynamic response example diagrams at side
1	Fast - default (1)
2	Standard
3	Smooth
4	Open Loop

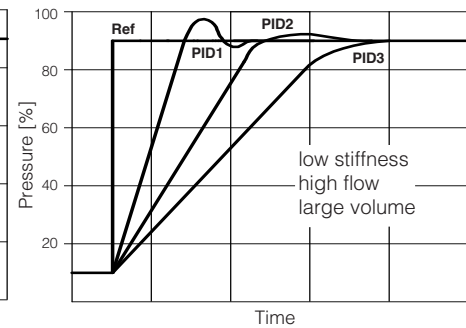
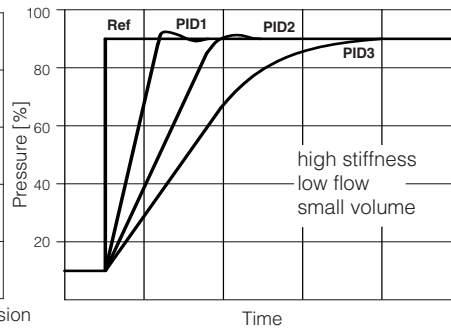

(1) interchangeable with previous TERS version

Above indications have to be considered as a general guideline, being affected by hydraulic circuit stiffness, working flow and dead volume. The valve's dynamics can be further optimized on the specific application, customizing PIDs parameters.

9 PRESSURE TRANSDUCER FAILURE

In case of pressure transducer failure, the valve's reaction can be configured through Atos E-SW software to:

- cut off the current to solenoid, therefore the regulated pressure will be reduced to minimum value (default setting)
- automatically switch the pressure control from closed loop (PID1,2,3) to open loop (PID4), to let the valve to temporarily operate with reduced regulation accuracy

10 ELECTRONIC OPTIONS

Standard driver execution provides on the 7 pin main connector:

Power supply - 24 VDC must be appropriately stabilized or rectified and filtered; a 2,5 A fuse time lag is required in series to each driver power supply. Apply at least a 10000 µF/40 V capacitance to single phase rectifiers or a 4700 µF/40 V capacitance to three phase rectifiers

Reference input signal - analog differential input with 0÷+10 V_{DC} nominal range (pin D,E), proportional to desired valve pressure regulation

Monitor output signal - analog output signal proportional to the actual valve pressure regulation = 0÷+10 V_{DC} nominal range

Note: a minimum booting time of 500 ms has been considered from the driver energizing with the 24 VDC power supply before the valve has been ready to operate. During this time the current to the valve coils is switched to zero.

10.1 Option /I

It provides 4 ÷ 20 mA current reference and monitor signals, instead of the standard 0÷+10 V_{DC}.

Input signal can be reconfigured via software selecting between voltage and current, within a maximum range of ±10 V or ±20 mA.

It is normally used in case of long distance between the machine control unit and the valve or where the reference signal can be affected by electrical noise; the valve functioning is disabled in case of reference signal cable breakage

10.2 Option /Q

To enable the driver, supply 24 VDC on pin C referred to pin B: Enable input signal allows to enable/disable the current supply to the solenoid, without removing the electrical power supply to the driver; it is used to maintain active the communication and the other driver functions when the valve has to be disabled. This condition does not comply with European Norms EN13849-1 (ex EN954-1).

10.3 Option /Z

It provides, on the 12 pin main connector, the following additional features:

Enable Input Signal

To enable the driver, supply 24 VDC on pin 3 referred to pin 2: Enable input signal allows to enable/disable the current supply to the solenoid, without removing the electrical power supply to the driver; it is used to maintain active the communication and the other driver functions when the valve has to be disabled. This condition does not comply with European Norms EN13849-1 (ex EN954-1).

Fault Output Signal

Fault output signal indicates fault conditions of the driver (solenoid short circuits/not connected, reference signal cable broken for 4÷20mA input, etc.). Fault presence corresponds to 0 VDC, normal working corresponds to 24 VDC (pin 11 referred to pin 2): Fault status is not affected by the Enable input signal

Power supply for driver's logics and communication

Separate power supply (pin 9,10) allow to cut solenoid power supply (pin 1,2) while maintaining active diagnostics, USB and fieldbus communication.

A safety fuse is required in series to each driver power supply: 500 mA fast fuse.

10.4 Possible combined options: /IQ, /IZ

11 ELECTRONIC CONNECTIONS

11.1 Main connector signals - 7 pin - standard and /Q option - RZMO-REB and RZMO-RES (A1)

PIN	Standard	/Q	TECHNICAL SPECIFICATIONS	NOTES
A	V+		Power supply 24 Vdc Rectified and filtered: $V_{RMS} = 20 \div 32 V_{MAX}$ (ripple max 10 % V_{PP})	Input - power supply
B	V0		Power supply 0 Vdc	Gnd - power supply
C	AGND		Analog ground	Gnd - analog signal
		ENABLE	Enable (24 Vdc) or disable (0 Vdc) the driver, referred to V0	Input - on/off signal
D	P_INPUT+		Pressure reference input signal: ± 10 Vdc / ± 20 mA maximum range Defaults are 0 \div 10 Vdc for standard and 4 \div 20 mA for /I option	Input - analog signal Software selectable
E	INPUT-		Negative reference input signal for P_INPUT+	Input - analog signal
F	P_MONITOR referred to: AGND V0		Pressure monitor output signal: 0 \div 10 Vdc / 0 \div 20 mA maximum range Defaults are 0 \div 10 Vdc for standard and 4 \div 20 mA for /I option	Output - analog signal Software selectable
G	EARTH		Internally connected to driver housing	

11.2 Main connector signals - 12 pin - /Z option - RZMO-REB and RZMO-RES (A2)

PIN	/Z	TECHNICAL SPECIFICATIONS	NOTES
1	V+	Power supply 24 Vdc Rectified and filtered: $V_{RMS} = 20 \div 32 V_{MAX}$ (ripple max 10 % V_{PP})	Input - power supply
2	V0	Power supply 0 Vdc	Gnd - power supply
3	ENABLE	Enable (24 Vdc) or disable (0 Vdc) the driver, referred to V0	Input - on/off signal
4	P_INPUT+	Pressure reference input signal: ± 10 Vdc / ± 20 mA maximum range Defaults are 0 \div 10 Vdc for standard and 4 \div 20 mA for /I option	Input - analog signal Software selectable
5	INPUT-	Negative reference input signal for P_INPUT+	Input - analog signal
6	P_MONITOR	Pressure monitor output signal: 0 \div 10 Vdc / 0 \div 20 mA maximum range, referred to V0 Defaults are 0 \div 10 Vdc for standard and 4 \div 20 mA for /I option	Output - analog signal Software selectable
7	NC	Do not connect	
8	NC	Do not connect	
9	VL+	Power supply 24 Vdc for driver's logic and communication	Input - power supply
10	VLO	Power supply 0 Vdc for driver's logic and communication	Gnd - power supply
11	FAULT	Fault (0 Vdc) or normal working (24 Vdc), referred to V0	Output - on/off signal
PE	EARTH	Internally connected to driver housing	

11.3 Communication connectors - RZMO-REB (B) and RZMO-RES (B) (C)

(B) USB connector - M12 - 5 pin always present		
PIN	SIGNAL	TECHNICAL SPECIFICATION (1)
1	+5V_USB	Power supply
2	ID	Identification
3	GND_USB	Signal zero data line
4	D-	Data line -
5	D+	Data line +

(C1) BC fieldbus execution, connector - M12 - 5 pin (2)		
PIN	SIGNAL	TECHNICAL SPECIFICATION (1)
1	CAN_SHLD	Shield
2	NC	do not connect
3	CAN_GND	Signal zero data line
4	CAN_H	Bus line (high)
5	CAN_L	Bus line (low)

(C2) BP fieldbus execution, connector - M12 - 5 pin (2)		
PIN	SIGNAL	TECHNICAL SPECIFICATION (1)
1	+5V	Termination supply signal
2	LINE-A	Bus line (high)
3	DGND	Data line and termination signal zero
4	LINE-B	Bus line (low)
5	SHIELD	

(C3) (C4) EH fieldbus execution, connector - M12 - 4 pin (2)		
PIN	SIGNAL	TECHNICAL SPECIFICATION (1)
1	TX+	Transmitter
2	RX+	Receiver
3	TX-	Transmitter
4	RX-	Receiver
Housing	SHIELD	

Notes: (1) shield connection on connector's housing is recommended (2) only for RES execution

11.4 Solenoid connection - only for RZMO-R

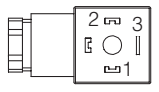
PIN	SIGNAL	TECHNICAL SPECIFICATION	Connector code 666 
1	COIL	Power supply	
2	COIL	Power supply	
3	GND	Ground	

11.5 Pressure transducer connection - only for RZMO-R

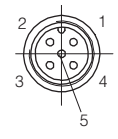
PIN	SIGNAL	TECHNICAL SPECIFICATION	Connector code ZBE-08 
1	V+	Power supply	
2	NC	Not connected	
3	Vout	output signal 4 \div 20 mA	
4	NC	Not connected	
5	NC	Not connected	

11.6 Connections layout - only for REB and RES

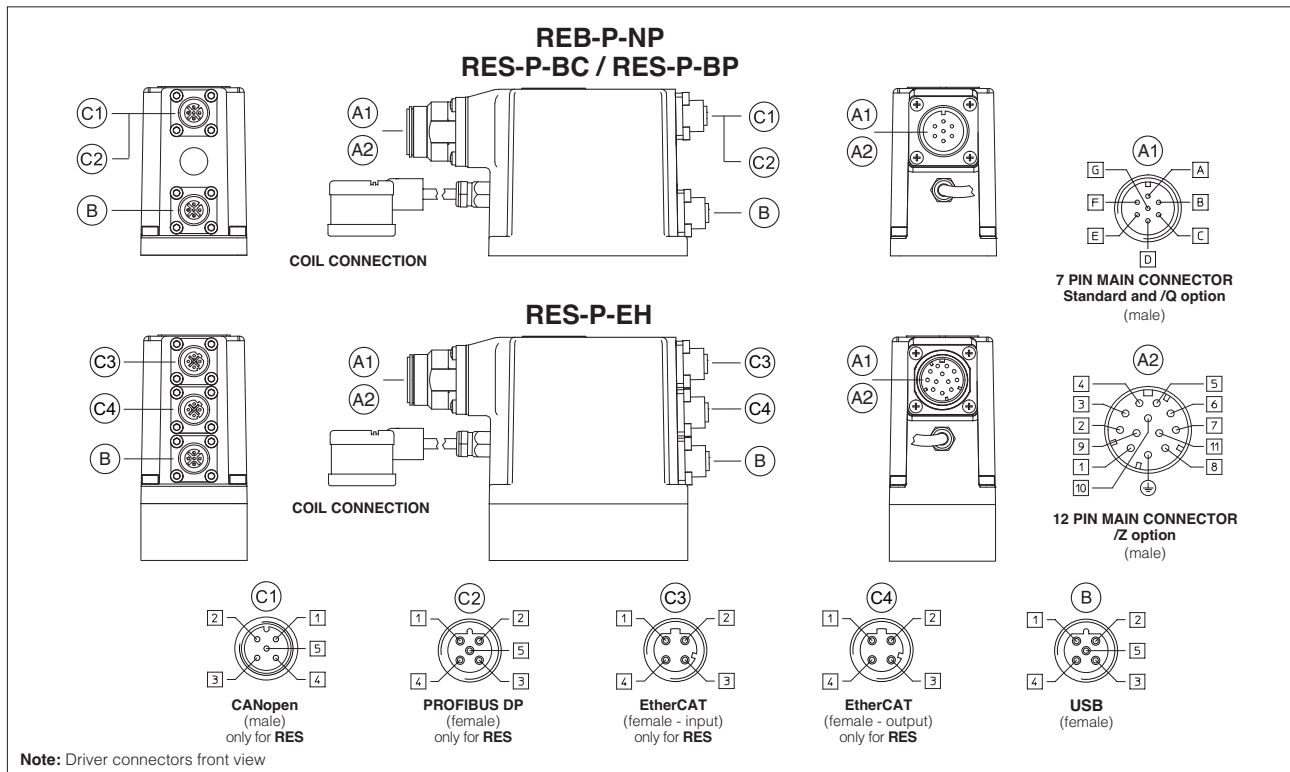

12 CONNECTORS

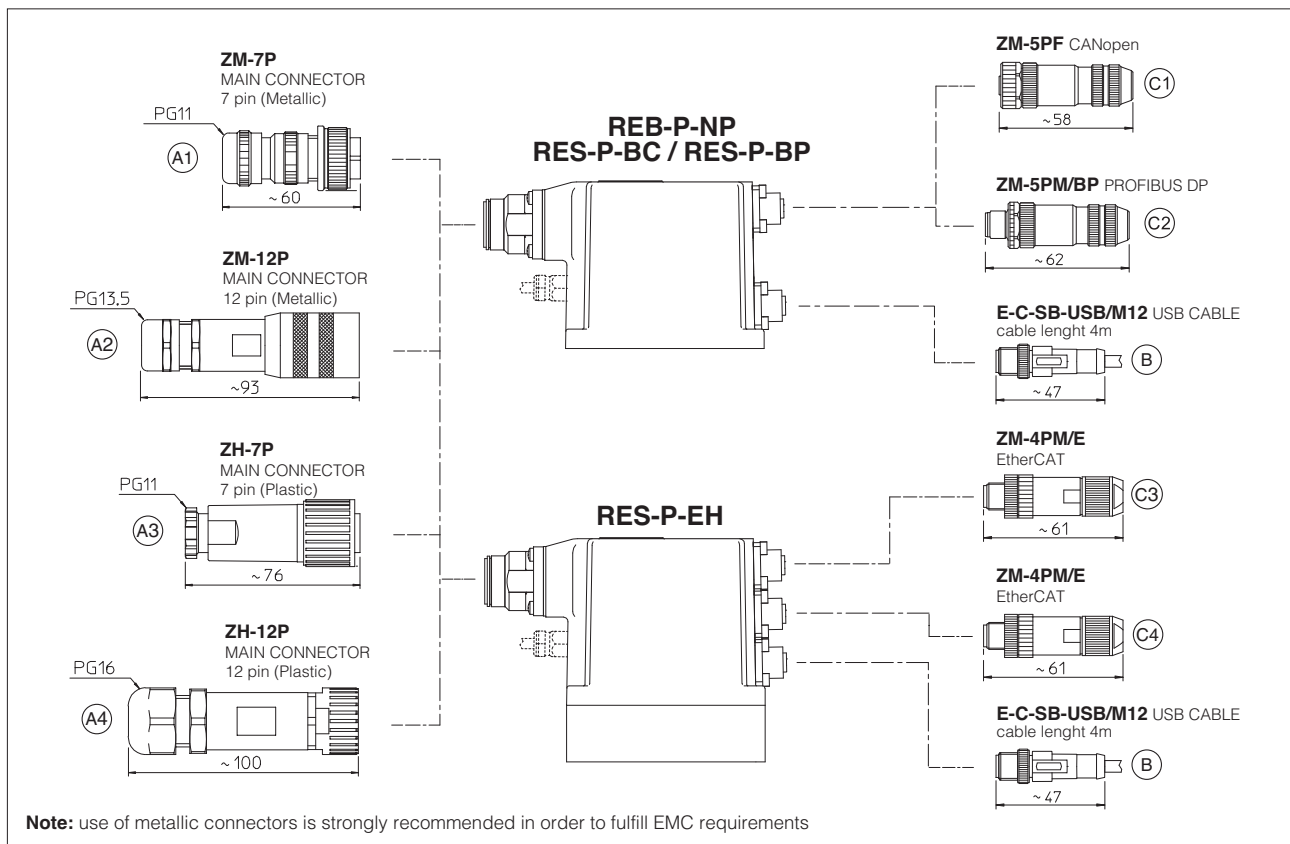

13 MODEL CODES OF MAIN CONNECTORS AND COMMUNICATION CONNECTORS - to be ordered separately

VALVE VERSION	R (1)		REB RES	REB/Z RES/Z	BC - CANopen	BP - PROFIBUS DP	EH - EtherCAT
	Power supply	Pressure transducer					
CONNECTOR CODE	666	ZBE-08	ZM-7P (A1)	ZM-12P (A2)	ZM-5PF (C1)	ZM-5PM/BP (C2)	ZM-4PM/E (C3)
			ZH-7P (A3)	ZH-12P (A4)			ZM-4PM/E (C4)
PROTECTION DEGREE	IP65		IP67				
DATA SHEET	K500		GS205, K500				

(1) Connectors supplied with the valve

only for RES-P

14 PROGRAMMING TOOLS - see tech table **GS500**

Valve's functional parameters and configurations, can be easily set and optimized using Atos E-SW programming software connected via USB port to the digital driver. For fieldbus versions, the software permits valve's parameterization through USB port also if the driver is connected to the central machine unit via fieldbus.

The software is available in different versions according to the driver's options:

E-SW-BASIC support: NP (USB) PS (Serial) IR (Infrared)

E-SW-FIELDBUS support: BC (CANopen) BP (PROFIBUS DP) EH (EtherCAT)
EW (POWERLINK)

E-SW-*/PQ support: valves with SP, SF, SL alternated control (e.g. E-SW-BASIC/PQ)

WARNING: drivers USB port is not isolated!

The use of isolator adapter is highly recommended for PC protection (see table **GS500**)

USB connection

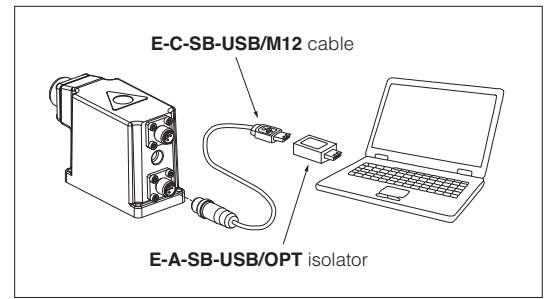

15 INSTALLATION DIMENSIONS [mm]

ISO 4401: 2005

Mounting surface:

4401-03-02-0-05 (see table P005)
(without ports A and B)

Fastening bolts:
4 socket head screws M5X50 class 12.9
Tightening torque = 8 Nm
Seals: 2 OR 108
Ports P, T: $\varnothing = 5$ mm

RZMO-R-P

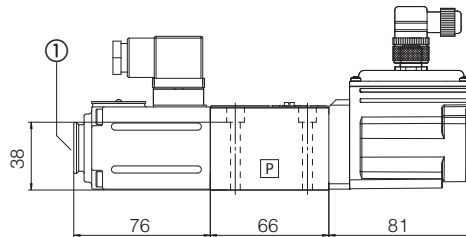
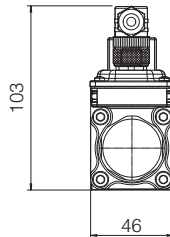

Mass: 2,1 kg

RZMO-REB-P-NP

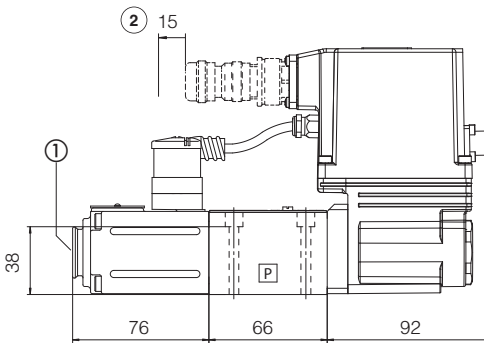
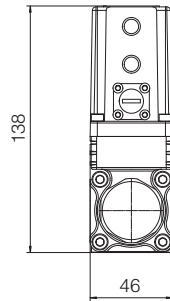

Mass: 2,6 kg

RZMO-RES-P-BP
RZMO-RES-P-BC

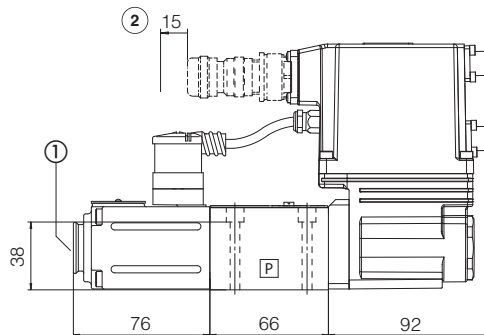
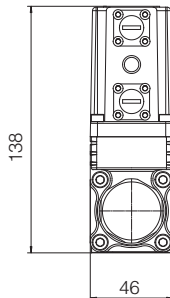

Mass: 2,6 kg

RZMO-RES-P-EH

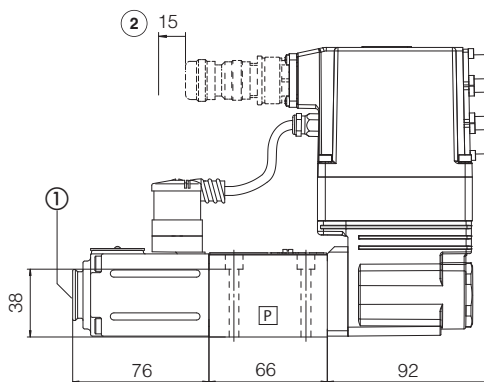
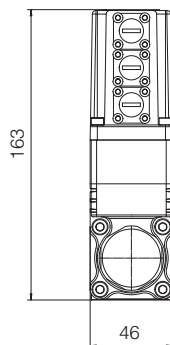

Mass: 2,7 kg

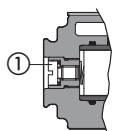

- ① = Screw for air bleeding: at the first valve commissioning the air eventually trapped inside the solenoid must be bled-off through the screw ①
- ② = Space to remove the 7 or 12 pin main connector. For main and communication connectors see section 12, 13